



Installation Manual for Müller SPRAYDOS controller

CENTERLINE 230BP

This installation manual covers installation of CenterLine 230BP with Müller SPRAYDOS controllers. We have endeavoured to deliver a fault free product. To ensure optimal use of the equipment, we ask you to pay great attention when reading this manual. Regarding responsibility for use of the product, we refer to our sales and delivery terms - especially paragraph 7, which follows:

7. Product usage.

7.1 Any use of the product is at the sole risk of the buyer. The buyer is therefore not entitled to any form for compensation caused by, for example, any of the following:

- Disturbance to/from any electronic services or products that do not confirm to the standards for CE marking,
- Missing or poor signal coverage or a succession hereof from external transmitters/receivers, used by the buyer,
- Functional faults, which apply to or from a PC-program or PC-equipment, not delivered by the seller.
- Faults that may arise from the buyers negligence to react to warnings and fault messages from the product, or which can be traced to negligence and/or absent constant control of the work carried out in comparison to the planned job.

7.2 When implementing any new equipment the buyer must take great care and pay attention. Any doubts as to correct operation/use should result in contacting TeeJet Technologies.

Enjoy work with CenterLine 230BP!

Kind regards,



Mølhavevej 2
9440 Aabybro
Denmark
Tel. +45 9696 2500
Fax +45 96962501
www.teejet.com

INTRODUCTION TO CENTERLINE 230BP

The Centerline 230BP is a combined Guidance and Automatic Boom Section Control (ABSC) device that features control of up to 15 boom sections. CenterLine 230BP connects in parallel to the existing wiring loom to the section valves.

PRINCIPLE OF OPERATION

The Centerline 230BP system controls the sections valves according to the GPS position and the GPS guidance makes it possible to avoid overlaps or skips.

The Centerline 230BP controls the section valves in automatic mode, and the controller section switches should be set to *off* unless the operator wants to override the auto mode and thus force spraying.

The Centerline 230BP monitors the controller section switches that controls the valves in manual mode. The Master switch can be used both in automatic mode as well as in manual mode.

Required Parts

To add Automatically Boom Section Control to a Müller SPRAYDOS controller the following part numbers are required:

Part No.	Description
90-02483-xx*	CenterLine 230BP
903-326	ABSC adapter box kit for Müller SPRAYDOS, 5 sections
903-325	ABSC adapter box kit for Müller SPRAYDOS, 7 sections
903-327	ABSC adapter box kit for Müller SPRAYDOS, 9 sections

*Specifies the required manual language; e.g. 90-02483-UK

SYSTEM OVERVIEW:

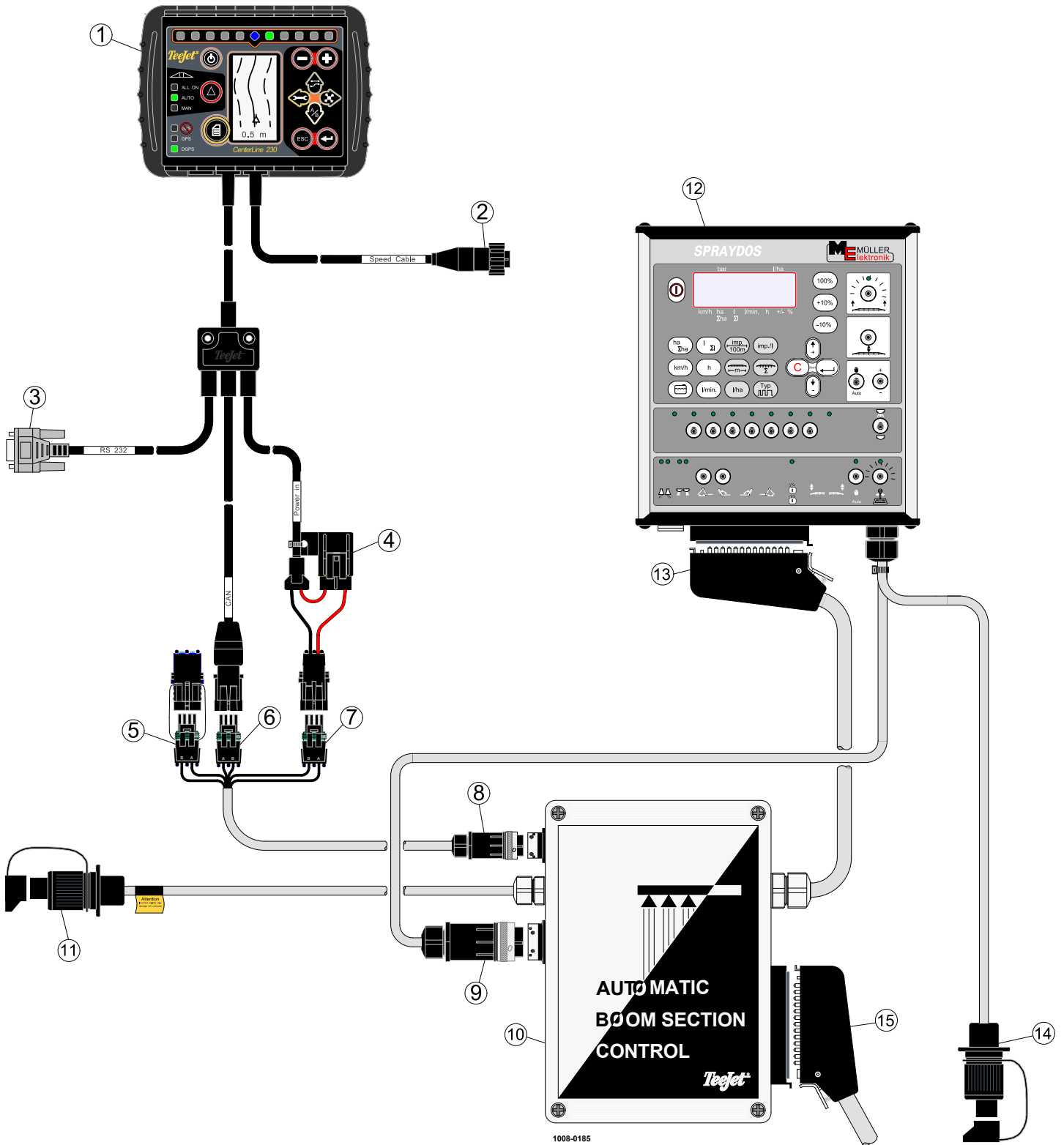

Note: CenterLine 230 is powered by the ABSC adapter box.

SYSTEM DESCRIPTION:

POS	DESCRIPTION
1	CenterLine 230BP
2	Speed output connector
3	RS232 port (Programming and GPS input)
4	Fuse 3A
5	Foot switch connector 2P (Foot switch is optional)
6	CAN connector 4P
7	Power connector 2P
8	BoomPilot adapter cable (PN 199-263)
9	Müller SPRAYDOS adapter cable, (! Different part number for 5, 7 and 9 section)
10	ABSC adapter box, PN 902-361
11	Power connector, ABSC adapter box
12	SPRAYDOS controller
13	Machine connector from ABSC box
14	Power connector, Müller SPRAYDOS
15	Machine connector from Sprayer

INSTALLING THE SPRAYDOS ADAPTER CABLE

To get electrical contact with the sections and the Master switch in the SPRAYDOS, it's necessary to install the adapter cable (POS. 9), in the SPRAYDOS controller. This is a critical operation and must only be conducted of persons with the necessary skills.

In case the SPRAYDOS controller is damaged during the installation, it's on the buyers sole risk and therefore the buyer is not entitled to any form for compensation.

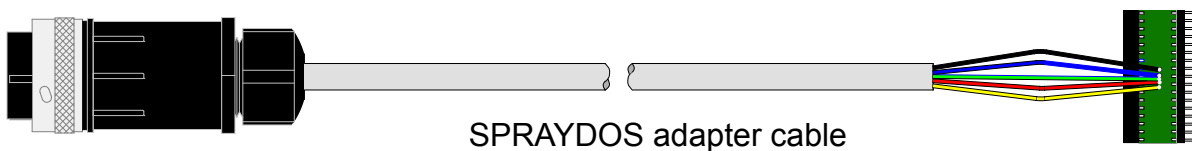



Unscrew the top and bottom endplate of the SPRAYDOS controller.

Pull carefully the keypad incl. The circuit board out of the profile until you can see the buzzer in the bottom of the profile. Be care full, the wires are just long enough to make it possible to unscrew the buzzer from the profile.

! Not all SPRAYDOS controllers has the buzzer fastened as shown, some has it placed on the circuit board.

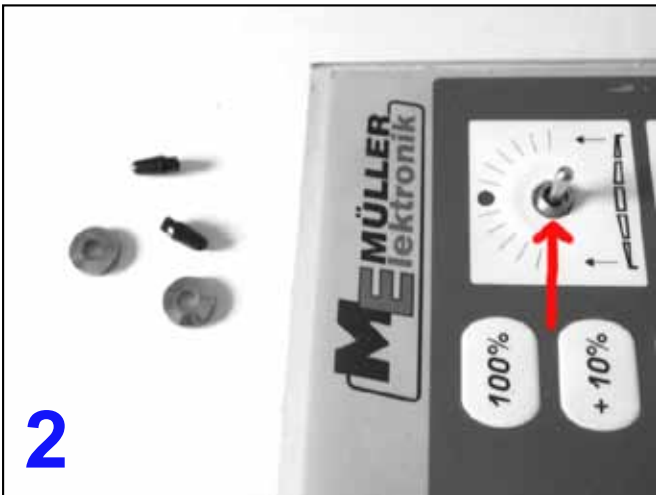

Pull off the black plastic caps on the switch's and unscrew all the small nuts.

Turn the unit around and unscrew the two 3 mm screws, which connect the circuit board with the keypad in the top of the controller.

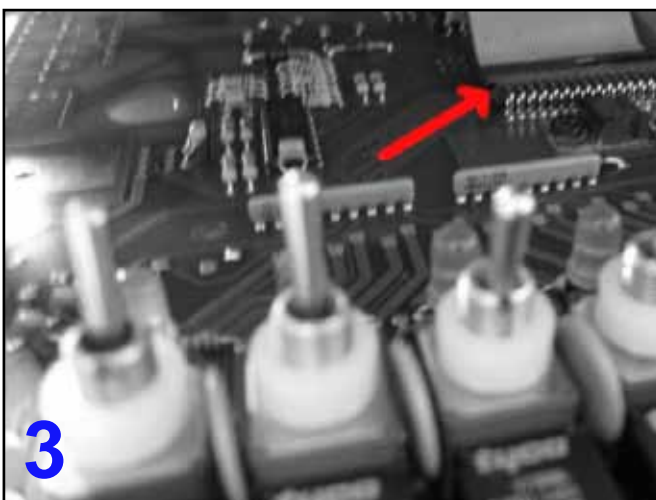

Lift the keypad and pull the controller flex cable carefully out of the connector.

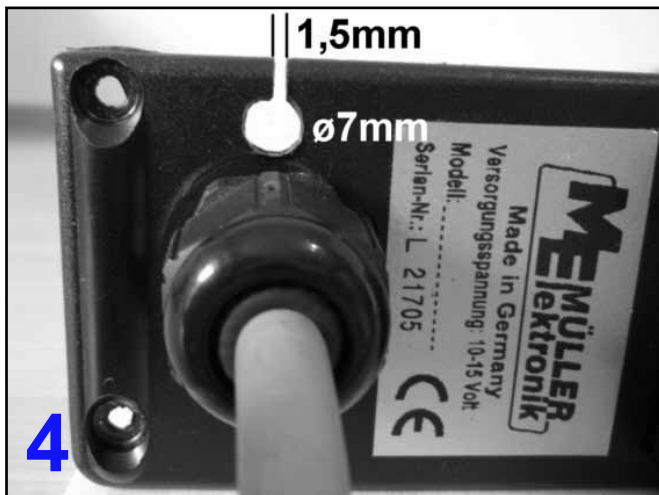

Drill a 7 mm hole in the bottom plastic end plate between the power cable gland and the rear edge of the end plate.

Make a 1,5 mm gab as shown on the picture.

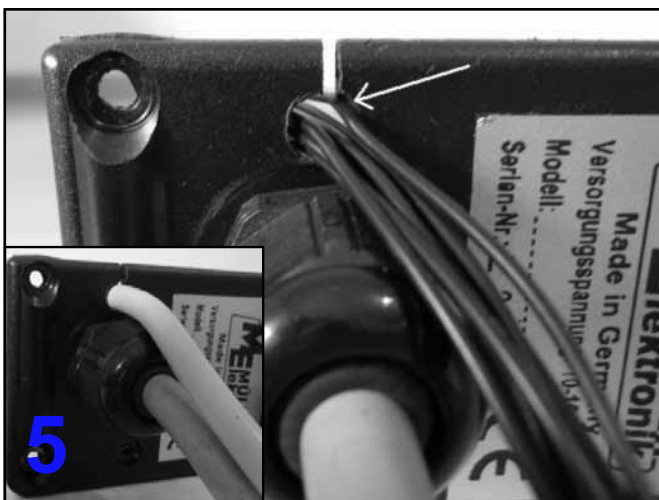

Place the free wires of the SPRAYDOS adapter cable one by one in the hole and pull the cable trough as shown.

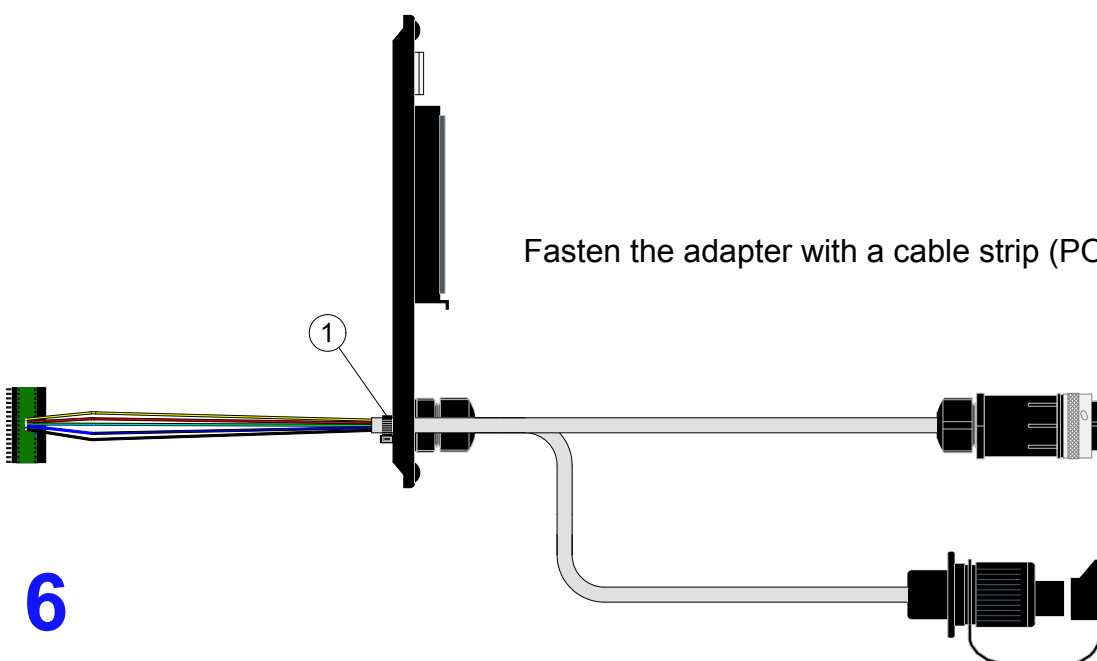

Fasten the adapter with a cable strip (POS 1).

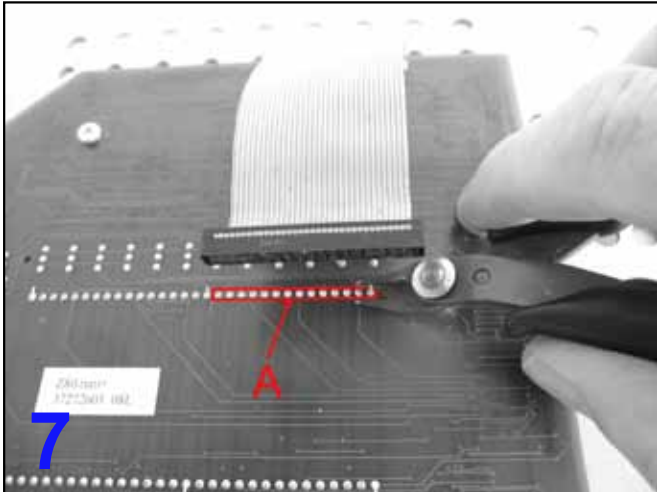

To protect the controller flex cable against the sharp ends shown on the picture, it's necessary to cut these (A). Cut 14 ends with a sharp suitable tool.

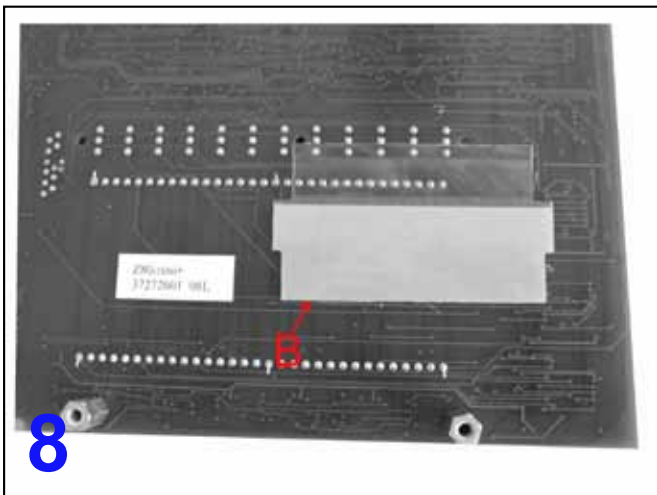

Place the protection plastic plate (B) with the adhesive tape as shown on the picture.

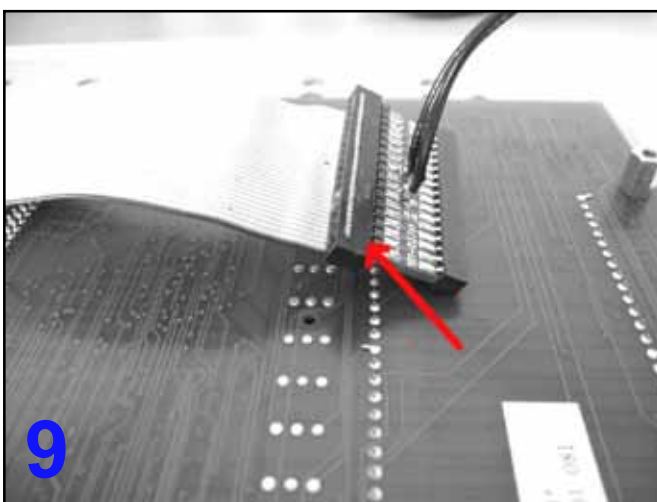

Connect the small adapter circuit board to the keypad flat cable connector as shown on the picture.

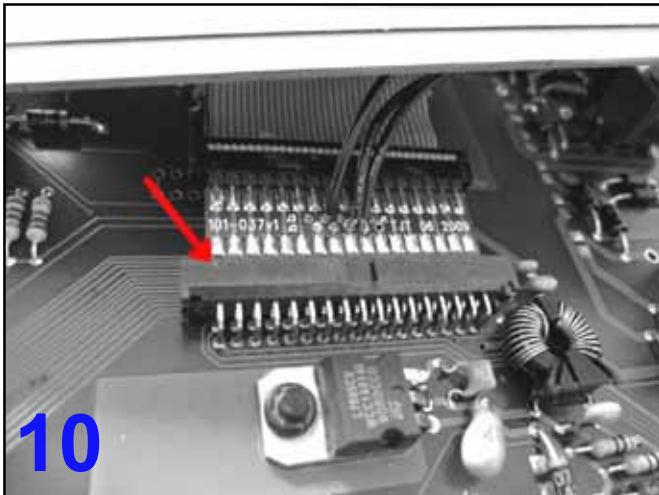

Connect the small adapter circuit board to the controller board. Make sure the connectors are correct positioned and fully connected.

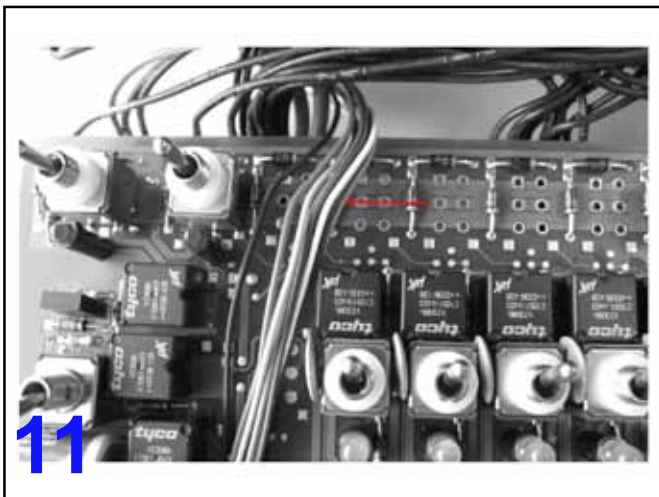

Place the adapter cable wires inside the controller.

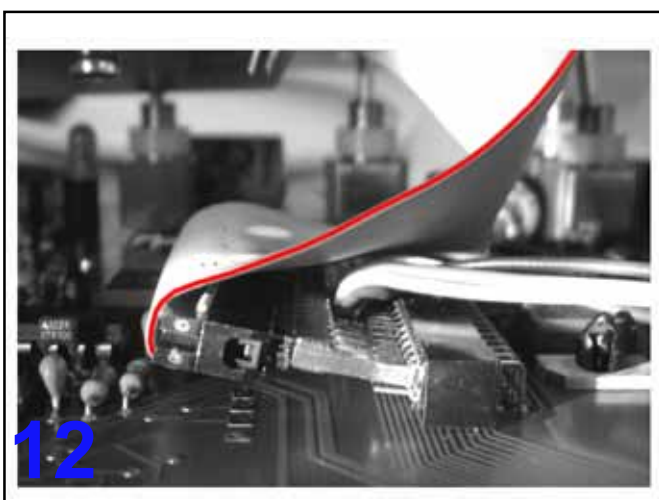

Place the flex cable inside the controller.
Mount the keypad again.

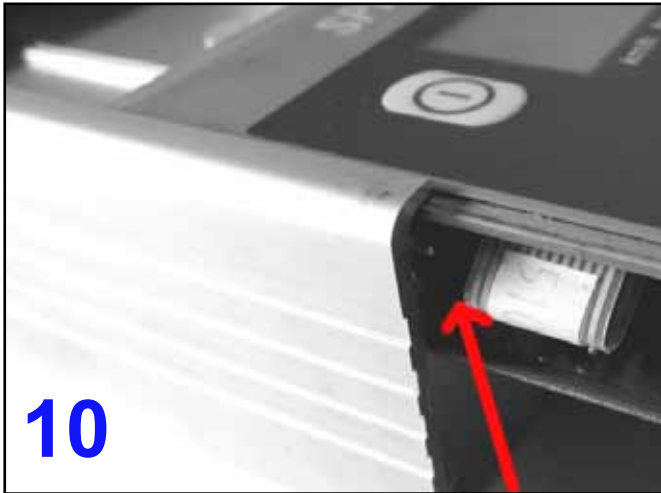

Be care full when the keypad is mounted in the profile again. There is a risk for damaging the flex board.

Assemble the controller again and connect the system as shown in the system overview drawing.

CONNECTING POS. 11 & 14 TO POWER:

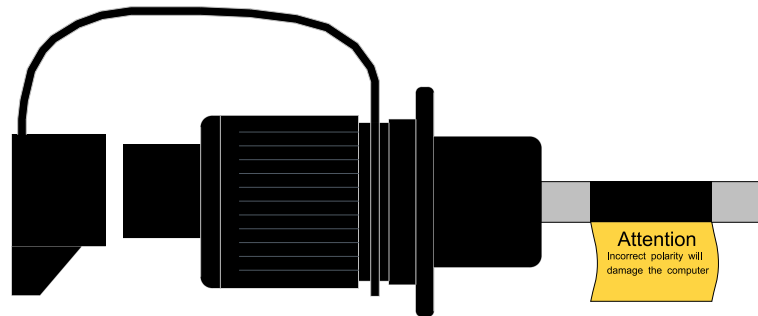
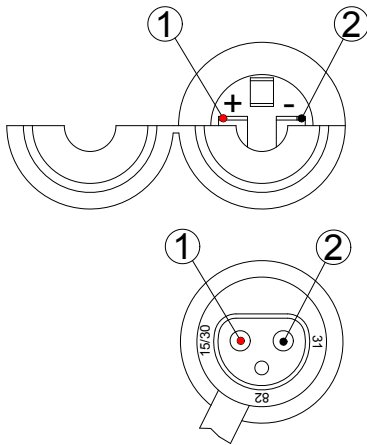

! When connecting the system to 12V power it's very important that the polarity is correct, if not the system will be damaged.

POS	DESCRIPTION
1	+12V (15/30)
2	Ground (31)

The power supply must be strong enough to operate the Section and Master valves. The total current will depend on the used valve type.

BATTERY CABLE (OPTION):

If a power connector (Socket) isn't available in the tractor cabin, a optional battery cable can be used (PN 96ET14).



SYSTEM CHECK:

After connecting the two power connectors, it's time to make a system check. To check the system it's necessary to have full GPS signal so the vehicle must be placed outside.

Check AUTO mode:

SPRAYDOS Controller:

- Set the section switch's off
- Set the Master switch on
- Turn the SPRAYDOS on

CL230:

- Turn the CL230 on
- Encode the number of sections and the width of each (Refer to the CL230 user manual)
- Wait for DGPS (Green LED on)
- Set the mode to AUTO
- Drive forward (Min. Speed 2.3 km/h)
- Observe that all sections and the master valve open.
- Check that the Master valve closes when the Master switch is set off.
- Check hectare counter in CL230 against SPRAYDOS.

Check MAN mode:

CL230:

- Set the mode to MAN

SPRAYDOS Controller:

- Set the section switch's on
- Set the Master switch on
- Observe that all sections and the master valve open.

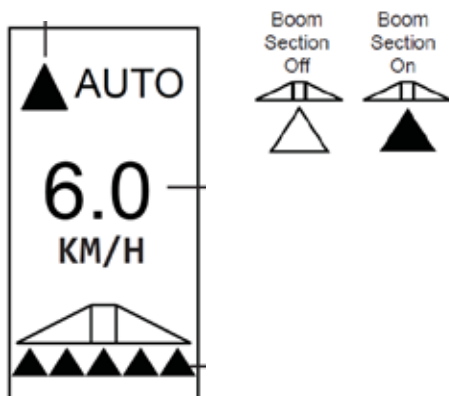

Check in the 'Boom Section Control Screen' that the section icons turn off and on according to the valve/switch status.