





 Incassi - Semincassi
Recessed - Semi-recessed



9100R + M.ANE.0001



9100R + M.ANE.0002





9100R + M.ANE.0003



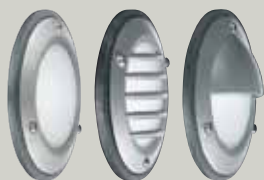

9100R



	9100R/1B1 6W GX53	Fluorescente compatta / Compact fluorescent
	9100R/1U1 40W G9	Alogena 2 PIN / 2 PIN Halogen
	9100R/1Z1* 1,5W GX53	Led bianchi alim. interno / Self-ballasted white Led

9100C



	9100C/1B1 6W GX53	Fluorescente compatta / Compact fluorescent
	9100C/1U1 40W G9	Alogena 2 PIN / 2 PIN Halogen
	9100C/1Z1* 1,5W GX53	Led bianchi alim. interno / Self-ballasted white Led

Tipo Diffusore / Emissione

Diffuser / Emission Tipology

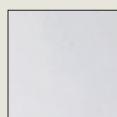

VS
Vetro Satinato
Satin Finish Glass

Colori corpo

Body colours

00 Bianco White **09** Grigio Grey **30** Antracite Anthracite

Colori anello

Ring colours

00 Bianco White **09** Grigio Grey **30** Antracite Anthracite **98** ** Acciaio lucido Polished steel

Caratteristiche Costruttive

Structural Construction

STRUTTURA

- Corpo in pressofusione di alluminio Lega EN AB 46100
- Cornice : Acciaio inox lucido AISI316 (M.ANE.0001)
Pressofusione di alluminio Lega EN AB 46100 (M.ANE.0002/0003)
- Cassaforma per incasso in Polipropilene PP caricato stabilizzato UV GWT750°C cat.V2
- Diffusore in vetro temperato acidato
- Dotazione : Guarnizione vetro in Etilene-propilene (EPDM) 40sh
Entrata singola del cavo di alimentazione con passacavo in PVC 70sh
Viteria esterna in acciaio Inox A2
Molle per incasso su controsoffitto spessore 12÷30mm
- Verniciatura in polvere poliestere resistente alla corrosione e alle nebbie saline (ISO7523)

CABLAGGIO

- Portalamпада GX53 per lampada fluor.compatta/Led

CARATTERISTICHE

- Tipologia installazione : Parete/Soffitto - Semi-incasso parete/soffitto
- Grado di protezione : IP65
- Classe di Isolamento I
- Installabile su superfici normalmente infiammabili
- Conforme alla Norma EN 60598 (CEI 34-21) e prescrizioni particolari

STRUCTURE

- Body die-cast aluminium - Alloy EN AB 46100
- Bezel: Polished finish stainless steel (M.ANE.0001)
Die-cast aluminium - Alloy EN AB 46100 (M.ANE.0002/0003)
- Recess mounting box PP polypropylene UV stabilised GWT750°C cat.V2
- Diffuser acid etched toughened safety glass
- Fittings: Ethylene-propylene (EPDM) 40 sh seal for sealing glass
Single cable entry with a PVC 70 sh cable gland
A2 stainless steel exterior screw fixtures
Spring clips for recess mounting in false ceilings with a 12÷30mm thickness
- Polyester powder paint finish resistant to corrosion and sea mist (ISO72523)

WIRING

- Lamp socket Gx53 for compact fluorescent / LED lamps

FEATURES

- Installation: Wall / Ceiling - Semi-recessed wall / ceiling
- Degree of protection: IP65
- Insulation class I
- Can be installed on flammable surfaces
- Conforms to the standard EN 60598 (CEI 34-21) and specific provisions

Codifica

Product Code Number

I codici riportati in tabella sono riferiti al solo corpo lampada. L'articolo finale è dato da: codice corpo + codice anello

ES. **9100R/1 B1 .VS .30 + M.ANE.0002.09**
Omega 6W GX53 Vetro satinato colore antracite + anello griglia colore grigio argento.

The product code numbers provided in the table refer to lighting fixture body only.
Product coding consists of: code number body + code number ring

E.G. **9100R/1 B1 .VS .30 + M.ANE.0002.09**
Omega 6W GX53 Satin finish glass colour anthracite + silver grey coloured grooved ring.

Note

Remarks

* Disponibile anche nei colori: **Z2** Verde
Z3 Rosso
Z4 Blu

* Available also in these colours: **Z2** Green
Z3 Red
Z4 Blue

** Solo per M.ANE.0001

** Only for M.ANE.0001



Dati fotometrici

Photometric data

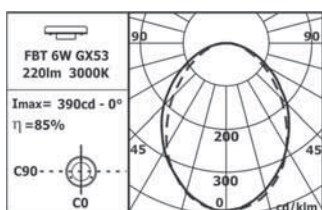
9100R/1B1.VS +
M.ANE.0001

C ₀₋₁₈₀ =59°		h	d	Em	Emax
		(m)	(m)	(lux)	(lux)
1	1,1	1	1,1	61	86
2	2,3	2	2,3	15	21
3	3,4	3	3,4	7	10

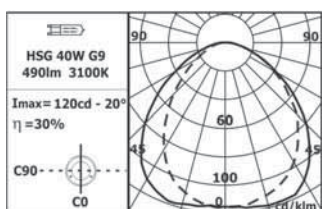
9100R/1U1.VS +
M.ANE.0001

C ₀₋₁₈₀ =33°+38°		h	d1	d2	Em	Emax
C ₉₀₋₂₇₀ =29°+34°		(m)	(m)	(m)	(lux)	(lux)
1	1,5	1,3	22	30		
2	2,8	2,4	5	8		
3	4,3	3,7	2	3		

9100R/1B1.VS +
M.ANE.00029100R/1B1.VS +
M.ANE.00039100R/1B1.VS +
M.ANE.0001

Diagramma Isolux Pavimento
Altezza di installazione 0,3m
Distanza apparecchi 3m

Floor Isolux Diagram
Installation Height 0,3m
Distance 3m

9100R/1B1.VS +
M.ANE.0002

Diagramma Isolux Pavimento
Altezza di installazione 0,3m
Distanza apparecchi 3m

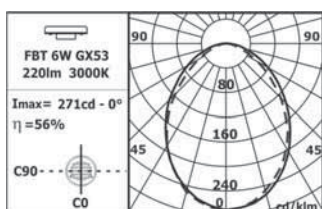
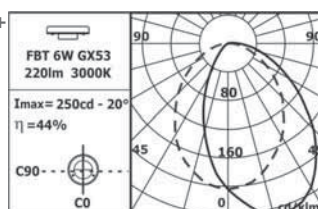
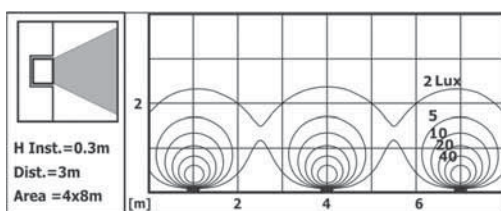
Floor Isolux Diagram
Installation Height 0,55m
Distance 6m

9100R/1B1.VS +
M.ANE.V0003

Diagramma Isolux Pavimento
Altezza di installazione 0,3m
Distanza apparecchi 3m

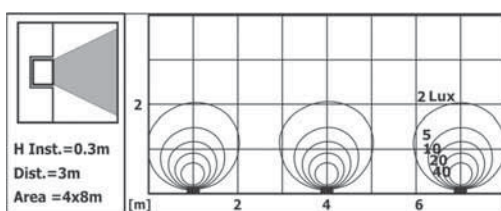
Floor Isolux Diagram
Installation Height 0,3m
Distance 3m

9100R/1U1.VS +
M.ANE.0001

Diagramma Isolux Pavimento
Altezza di installazione 0,3m
Distanza apparecchi 3m

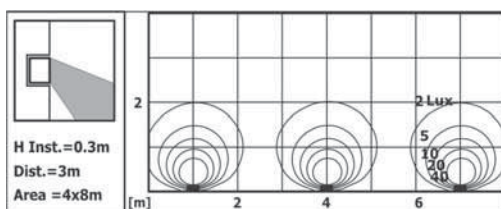
Floor Isolux Diagram
Installation Height 0,3m
Distance 3m

Dati tecnici

Technical data

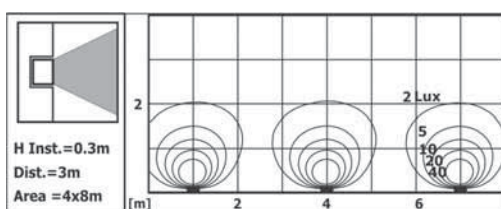
9100R/1 + M.ANE.0001

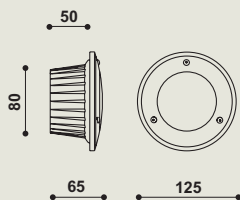

9100R/1 + M.ANE.0002

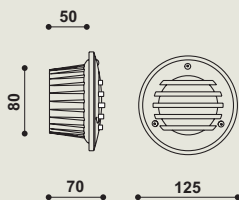

9100R/1 + M.ANE.0003

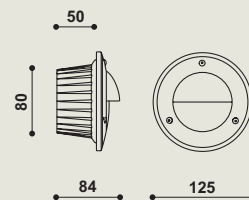

quote in millimetri
dimensions in millimetres

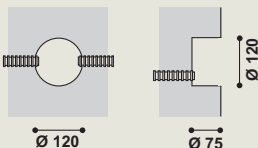

Dimensioni foro per cassaforma da incasso
La cassaforma deve essere installata a filo parete

Size of recess hole for mounting box
The mounting box must be installed flush to wall.

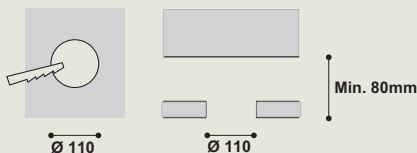

Dimensioni foro per controsoffittatura
Spessore controsoffitto = 10÷40mm
Mantenere una distanza minima dal soffitto di 30mm

Size of recess hole for mounting in false / suspended ceilings
False ceiling thickness = 10÷40mm
Mount fixture at a minimum distance of 30 mm from ceiling



Versione Incasso Parete
L'apparecchio viene fornito con cassaforma in PP Polipropilene da incasso a parete, predisposta per l'ingresso dell'alimentazione, dal fondo e dalle pareti laterali

Recessed wall fixture
This lighting fixture is supplied with a PP polypropylene recess mounting box for wall mounting and has cable entry from bottom and side walls



Versione Incasso Soffitto
L'apparecchio viene fornito con molle in acciaio per incasso in controsoffittature

Recessed ceiling fixture
The lighting fixture is supplied with stainless steel spring clips for recess mounting in false / suspended ceilings





9150C



9151P



9150C



9150C/1B1

6W GX53

Fluorescente compatta / Compact fluorescent



9150C/1U1

40W G9

Alogena 2 PIN / 2 PIN Halogen

9151P



9151P/1B1

6W GX53

Fluorescente compatta / Compact fluorescent



9151P/1U1

40W G9

Alogena 2 PIN / 2 PIN Halogen

Tipo Diffusore / Emissione

Diffuser / Emission Tipology

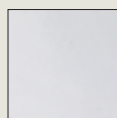

VS
Vetro Satinato
Satin Finish Glass

Colori corpo

Body colours



00 Bianco White



09 Grigio Grey



30 Antracite Anthracite

Colori anello

Ring colours



00 Bianco White



09 Grigio Grey



30 Antracite Anthracite



98 Acciaio lucido Polished steel

Caratteristiche Costruttive

Structural Construction

STRUTTURA

- Corpo in pressofusione di alluminio Lega EN AB 46100
- Cornice : Acciaio inox lucido AISI316 (M.ANE.0001)
- Picchetto in Poliammide PA6 V2 GWT960°C per fissaggio a terra
- Diffusore in vetro temperato acidato
- Dotazione : Guarnizione vetro in Etilene-propilene (EPDM) 40sh
Guarnizione elementi in Gomma Nitrilica (NBR) 60sh
Entrata singola del cavo di alimentazione con passacavo in PVC 70sh
Viteria esterna in acciaio Inox A2
- Verniciatura in polvere poliestere resistente alla corrosione e alle nebbie saline (ISO7523)

CABLAGGIO

- Configurazione con picchetto : cavo esterno H05RN-F L=200mm con morsetti a tripolare stagna IP68
- Portalamada GX53 per lampada fluor.compatta/Led

CARATTERISTICHE

- Tipologia installazione : Parete / Soffitto / Terra (con picchetto)
- Grado di protezione : Supporto orientabile IP54
Corpo apparecchio IP65
- Classe di Isolamento I
- Installabile su superfici normalmente infiammabili
- Conforme alla Norma EN 60598 (CEI 34-21) e prescrizioni particolari

STRUCTURE

- Body die-cast aluminium - Alloy EN AB 46100
- Bezel: Polished finish stainless steel (M.ANE.0001)
- Polyamide mounting stake PA6 V2 GWT960°C for ground installation
- Diffuser acid etched toughened safety glass
- Fittings: Ethylene-propylene (EPDM) 40 sh seal for sealing glass
Nitrile rubber seals (NBR) 60sh
Single cable entry with a PVC 70 sh cable gland
A2 stainless steel exterior screw fixtures
- Polyester powder paint finish resistant to corrosion and sea mist (ISO7523)

WIRING

- For stake mounting: external cable H05RN-F L=200mm with IP68 sealed three-phase terminal junction box
- Lamp socket Gx53 for compact fluorescent / LED lamps

FEATURES

- Installation: Wall / Ceiling / Ground (with mounting stake)
- Degree of protection: Tilting support IP54
Lighting fixture body IP65
- Insulation class I
- Can be installed on flammable surfaces
- Conforms to the standard EN 60598 (CEI 34-21) and specific provisions

Codifica

Product Code Number

I codici riportati in tabella sono riferiti al solo corpo lampada.
L'articolo finale è dato da: codice corpo + codice anello

ES. 9151P/1 B1 .VS .30 + M.ANE.0001.98
Omega 6W GX53 Vetro satinato colore antracite +
anello in acciaio lucido.

The product code numbers provided in the table refer to lighting fixture body only.

Product coding consists of: code number body + code number ring o

E.G. 9151P/1 B1 .VS .30 + M.ANE.0001.98
Omega 6W GX53 Satin finish glass colour anthracite +
polished steel ring



Dati fotometrici

Photometric data

9150C/1B1 +
M.ANE.0001



Diagramma Isolux Parete
Distanza parete 0,2m
Distanza apparecchi 3m
Rotazione apparecchio 90°
verso pavimento

Wall Isolux Diagram
Wall distance 0,2m
Luminaire distance 3m
Luminaire tilt 90° to floor

9150C/1U1 +
M.ANE.0001

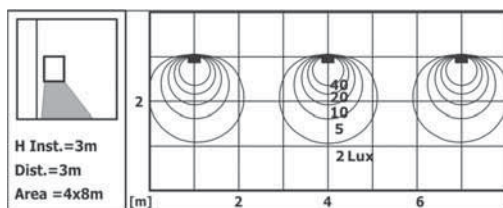

Diagramma Isolux Parete
Distanza parete 0,2m
Distanza apparecchi 3m
Rotazione apparecchio 90°
verso pavimento

Wall Isolux Diagram
Wall distance 0,2m
Luminaire distance 3m
Luminaire tilt 90° to floor

9151P/1B1 +
M.ANE.0001

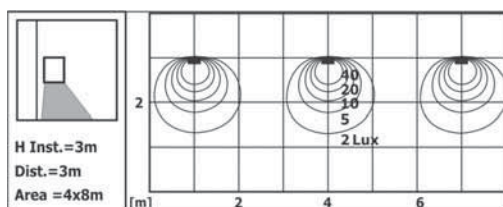

Diagramma Isolux Parete
Distanza parete 1m
Distanza apparecchi 3m
Rotazione apparecchio 45°
verso alto

Wall Isolux Diagram
Wall distance 1m
Luminaire distance 3m
Luminaire tilt 45° up

9151P/1U1 +
M.ANE.0001

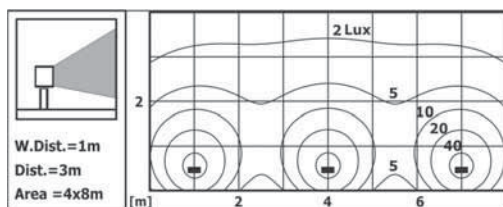

Diagramma Isolux Parete
Distanza parete 1m
Distanza apparecchi 3m
Rotazione apparecchio 45°
verso alto

Wall Isolux Diagram
Wall distance 1m
Luminaire distance 3m
Luminaire tilt 45° up

Dati tecnici

Technical data

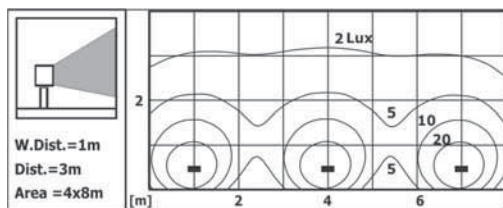
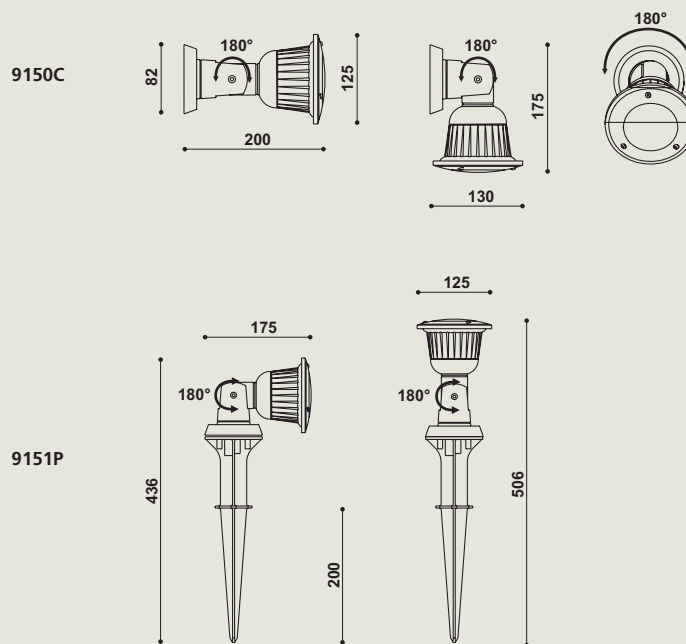

quote in millimetri
dimensions in millimetres

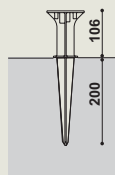
**Picchetto per installazione a terra art.9151P**

Materiale: PA Poliammide GWT960° V2

Dimensioni : Lunghezza totale 300mm

Lunghezza parte interrata 200mm

Mounting stake for ground installation art.9151P

Material: PA Polyamide GWT960° V2

Size: Total length 300mm

Length of stake in ground 200mm

Articolo 9151P

L'apparecchio viene fornito già cablato con cavo esterno tipo H05RN-F 3x1mmq lunghezza 200mm con morsettiera tripolare protetta IP68. Utilizzare cavo di alimentazione in doppia guaina tipo H07RN-F sez.minima 1,5mmq

**Article 9151P**

The lighting fixture is supplied wired with external power cable type H05RN-F 3x1mm² length 200mm with three-phase terminal junction box IP68 degree of protection. Use power cable with double sheath type H07RN-F minimum sec. 1.5mm²



E' inoltre prevista la possibilità di richiedere cavo con spina Shuko IP44 L=3m per il collegamento diretto alla rete.

It is possible to request a power cable with a Shuko plug IP44 L=3m for connecting to mains network





P0625 - P0620



U.V.



IP54



IK08



CL I



CE



P0600	1 Corpo illuminante Palo H 500 mm. 1 Lighting body Pole H 500 mm.
P0610	2 Corpi illuminanti Palo H 500 mm. 2 Lighting bodies Pole H 500 mm.
P0620	1 Corpo illuminante Palo H 850 mm. 1 Lighting body Pole H 850 mm.
P0630	2 Corpi illuminanti Palo H 850 mm. 2 Lighting bodies Pole H 850 mm.

P0605	1 Corpo illuminante Palo H 500 mm. 1 Lighting body Pole H 500 mm.
P0615	2 Corpi illuminanti Palo H 500 mm. 2 Lighting bodies Pole H 500 mm.
P0625	1 Corpo illuminante Palo H 850 mm. 1 Lighting body Pole H 850 mm.
P0635	2 Corpi illuminanti Palo H 850 mm. 2 Lighting bodies Pole H 850 mm.

Incassi - Semincassi
Recessed - Semi-recessed



Colori corpo

Body colours

- 00 Bianco White
- 09 Grigio Grey
- 30 Antracite Anthracite

Caratteristiche Costruttive

Structural Construction

STRUTTURA

- Base in pressofusione di alluminio Lega EN AB 46100
- Palo in alluminio estruso Sez.Rettangolare 30x100mm Lega EN-AW 6060
- Dotazione :
Passacavo in PVC 70sh
Viteria esterna in acciaio Inox A2
Flangia di ancoraggio su terreno con viti in acciaio inox
- Verniciatura in polvere poliestere resistente alla corrosione e alle nebbie saline (ISO7523)

CABLAGGIO

- Collegamento cavo alimentazione su testa palo

CARATTERISTICHE

- Tipologia installazione :
Palo con corpo fisso / orientabile 1-2 punti luce
- Grado di protezione : IP54
- Classe di Isolamento I
- Installabile su superfici normalmente incombustibili
- Conforme alla Norma EN 60598 (CEI 34-21) e prescrizioni particolari

STRUCTURE

- Base die-cast aluminium - Alloy EN AB 46100
- Post extruded aluminium with rectangular section 30x100mm Alloy EN-AW 6060
- Fittings:
PVC 70 sh cable gland
A2 stainless steel exterior screw fixtures
Flange for anchorage to ground with stainless steel screw fixtures
- Polyester powder paint finish resistant to corrosion and sea mist (ISO72523).

WIRING

- Power cable connected to post head

FEATURES

- Installation:
Post with fixed / tilting lighting fixture 1-2 lights
- Degree of protection: IP54
- Insulation class I
- Can be installed on flammable surfaces
- Conforms to the standard EN 60598 (CEI 34-21) and specific provisions

Codifica

Product Code Number

I codici riportati in tabella sono riferiti al solo sistema palo.
L'articolo finale è dato da:
codice palo + codice corpo + codice anello

ES. P0630.30 + 9100R/1 B1 .VS .30 + M.ANE.0001.98
Palo 2 punti luce fissi H850 colore antracite +
Omega 6W GX53 Vetro satinato colore antracite +
Anello in acciaio lucido.

The product code numbers provided in the table refer to post lighting fixture only.

Product coding consists of:
code number post + code number body + code number ring

E.G. P0630.30 + 9100R/1 B1 .VS .30 + M.ANE.0001.98
Post for 2 fixed lights H850 colour anthracite +
Omega 6W GX53 Satin finish glass colour anthracite +
polished steel ring

Dati fotometrici

Photometric data

P0620 + 9100R/1B1.VS + M.ANE.0001



Diagramma Isolux Pavimento
Altezza di installazione 0,85m
Distanza apparecchi 3m

Floor Isolux Diagram
Installation Height 0,85m
Distance 3m

P0620 + 9100R/1B1.VS + M.ANE.0002

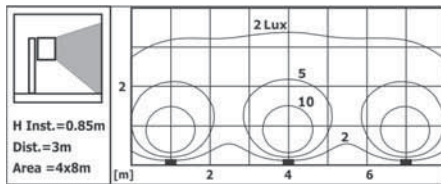

Diagramma Isolux Pavimento
Altezza di installazione 0,85m
Distanza apparecchi 3m

Floor Isolux Diagram
Installation Height 0,85m
Distance 3m

P0620 + 9100R/1B1.VS + M.ANE.0003

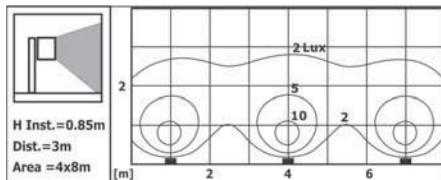

Diagramma Isolux Pavimento
Altezza di installazione 0,85m
Distanza apparecchi 3m

Floor Isolux Diagram
Installation Height 0,85m
Distance 3m

P0620 + 9100R/1U1.VS + M.ANE.0001

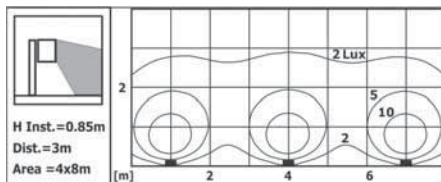

Diagramma Isolux Pavimento
Altezza di installazione 0,85m
Distanza apparecchi 3m

Floor Isolux Diagram
Installation Height 0,85m
Distance 3m

P0625 + 9150C/1B1.VS + M.ANE.0001

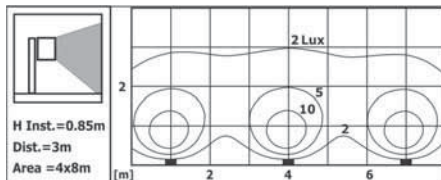

Diagramma Isolux Pavimento
Altezza di installazione 0,85m
Distanza apparecchi 3m
Inclinazione Apparecchio 45° sul pavimento

Floor Isolux Diagram
Installation Height 0,85m
Distance 3m
Luminaire tilt 45° to floor

Dati tecnici

Technical data

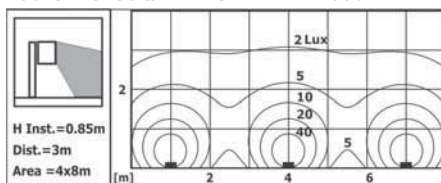
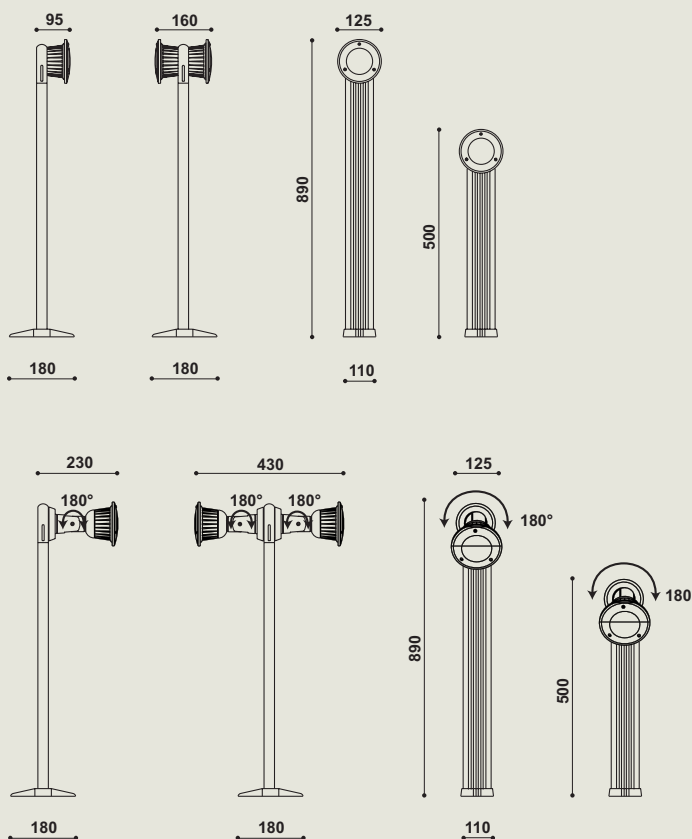

quote in millimetri
dimensions in millimetres

Fissaggio a terra Pali tipo P0600 ÷ P0635
Ground installation P0600 ÷ P0635

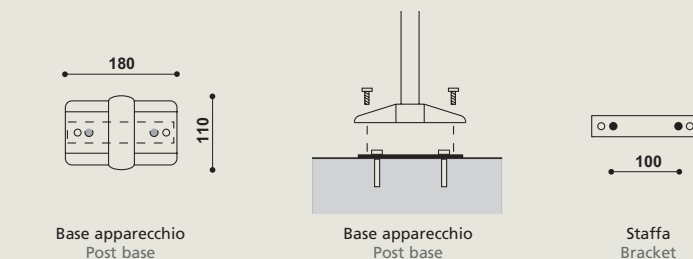

Base apparecchio
Post base

Base apparecchio
Post base

Staffa
Bracket

Ancoraggio con staffa in metallo verniciato da fissare su fondo in cemento tramite tasselli ad espansione in metallo. Passaggio del cavo alimentazione nella parte laterale. La disposizione dei corpi illuminanti viene definita in funzione dell'orientamento della staffa.

The post is installed and secured to the ground with a paint finish metal bracket which is fixed and secured to the concrete utilising metal anchor screw bolts and rawlplugs. The power supply cable is fed through the side. These post lighting fixtures are positioned and directed depending on the direction and position of the fixture bracket.

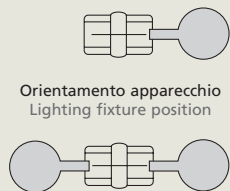

Orientamento apparecchio
Lighting fixture position



Il collegamento del cavo di alimentazione è previsto su testa palo tramite morsetteria con fissacavo protetta IP44. Utilizzare cavo tripolare in doppia guaina sez.max. 1,5mmq

The power cable is connected to the post head at the terminal junction box with a cable clamp IP44. Use a three-phase cable with double sheath max sec. 1.5 mm².







Incassi - Semincassi
Recessed - Semi-recessed

